

THIS DOCUMENT PROPRIETARY TO TITAN AIRCRAFT, AND IS NOT TO BE USED, CIRCULATED, REPRODUCED, COPIED, OR DISCLOSED IN ANY MANNER WITHOUT PRIOR WRITTEN PERMISSION OF AN AUTHORIZED OFFICIAL OF TITAN AIRCRAFT.

NICO DETAILS

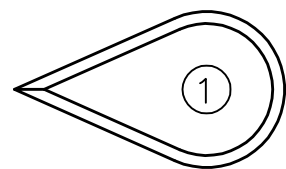

1) USE THE PROPER SIZE THIMBLE.

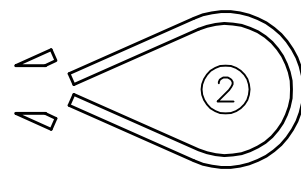

2) SNIP POINTED ENDS OFF.

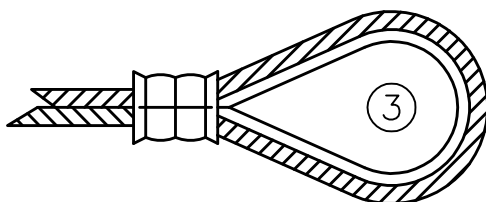

3) CRIMP

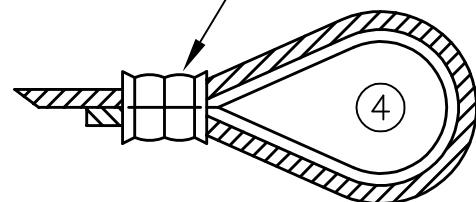

4) APP. 1/8" OF THE CABLE END SHOULD BE STICKING OUT OF THE NICO SLEEVE.

NOTE:  
THE PROPER NICO CRIMP DOES NOT CRIMP THE ENDS.

CLEVIS AND PIN DETAILS

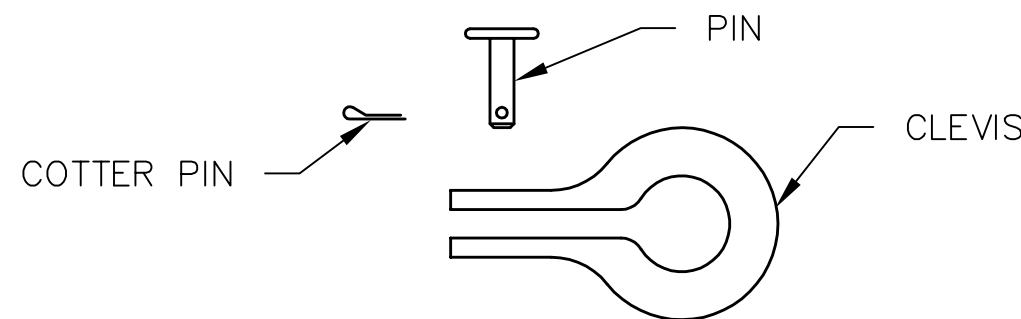

NOTES:

- PLACE CLEVIS AROUND PART.
- INSERT PIN THRU CLEVIS AND PART.
- INSERT COTTER PIN THRU PIN.
- NICO CABLE AROUND CLEVIS.

TURNBUCKLE DETAILS

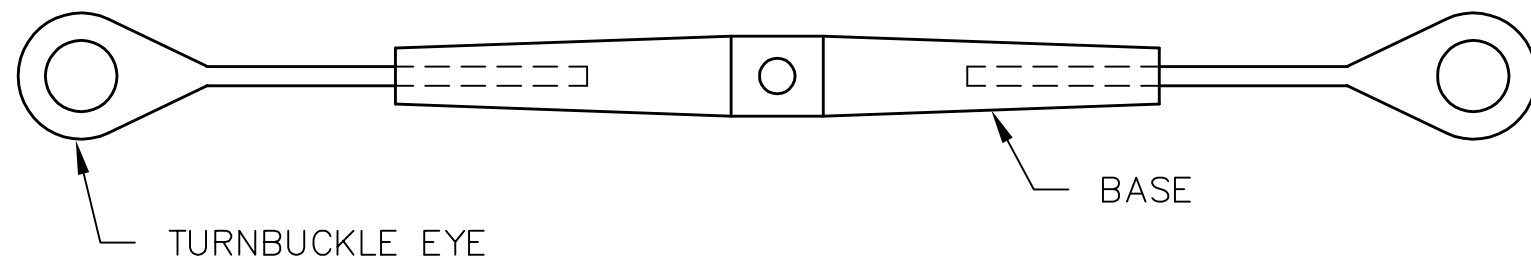

NOTES:

- INSERT TURNBUCKLE EYE INTO BASE. BE SURE TO ALLOW FOR ADEQUATE ADJUSTMENT BOTH WAYS.
- NICO PRESS CABLES TO TURNBUCKLE EYES. NICO THIMBLES MAY NEED TO BE COMPRESSED SLIGHTLY TO SLIDE EASILY THROUGH THE TURNBUCKLE EYE.

CABLE SWIVEL DETAILS

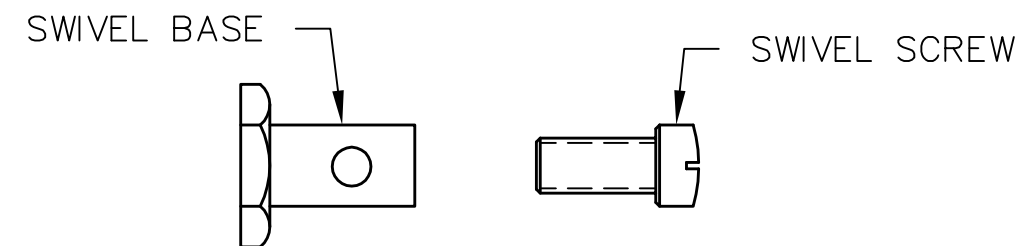

NOTES:

- SOLDER CABLE ENDS TO PREVENT FRAYING.
- INSERT SWIVEL BASE THRU PART.
- INSERT CABLE THRU SIDE HOLE ON SWIVEL BASE.
- TIGHTEN SCREW TO HOLD CABLE IN PLACE.



**TITAN AIRCRAFT SUPPLY**  
1419 STATE ROUTE 45 SOUTH  
AUSTINBURG, OHIO 44010

DETAIL NAME CABLE MOUNTING DETAILS

DRAWN J. PRESTON DATE 5/8/92

SCALE N/A PART NO. N/A

CHECKED DATE

ASSEMBLY NAME ALL CONTROL CABLES

APPROVED DATE

PART NO. N/A DRAWING NO.

DRAWING NO. **B 92-INS-0192-B**